

LED Panel Light

Back-Lit (5CCT & 5WATT in one, Tunable)



Key Features

- Energy-efficient
- Environmentally friendly
- Safe & easy to install
- Switchable design: 5 CCT in one

Optics

- CRI: >80
- Beam Angle: 120°
- Dimming: 0-10V

Electrical

- Input Voltage: 120-277V
- Temperature: -4°F-113°F

Lifespan

- Estimated 50,000 hours

Applications

- Offices/Hallways
- Schools
- Hospitals

Model Number	Length	Wattage	Lumens	CCT	Driver
ML-1*4-40-3065S	1'x4'	Selectable 20W/25W/30W/35W/40W	120Lm/W	Selectable 3K/35K/4K/5K/65K	Side
ML-2*2-40-3065S	2'x2'				
ML-2*4-72-3065S	2'x4'	Selectable 30W/40W/50W/60W/72W			
ML-2*2-40-3065K	2'x2'	Selectable 20W/25W/30W/35W/40W			Loose
ML-2*4-72-3065K	2'x4'	Selectable 30W/40W/50W/60W/72W			

Accessories

Model Number	Accessories	Size	Watt
ML-2x2-Surface-Backlit-Z	Surface Mount Kit	2ft x 2ft	-
ML-2x4-Surface-Backlit-Z	Surface Mount Kit	2ft x 4ft	
ML-1x4-Surface-Backlit-Z	Surface Mount Kit	1ft x 4ft	
ML-EDL-20W-54V	Backup Emergency Driver	-	20W

PRODUCT DIMENSIONS

1'x4'

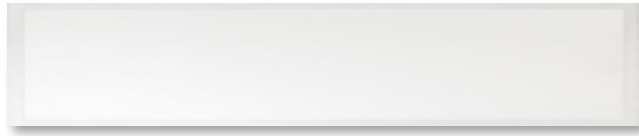

Front



Back



1.18"

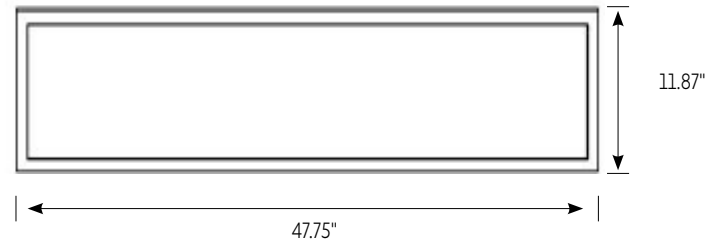

11.87"

47.75"

2'x4'



Front



Back

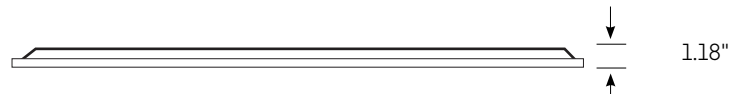

1.18"

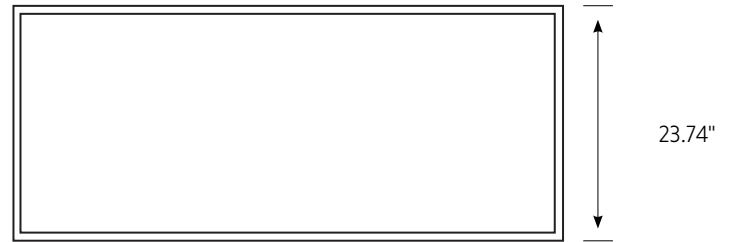

23.74"

47.75"

2'x2'

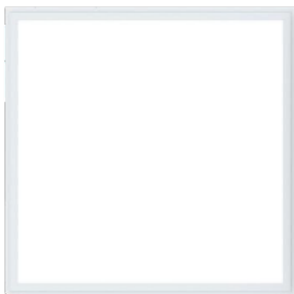

Front



Back



1.18"

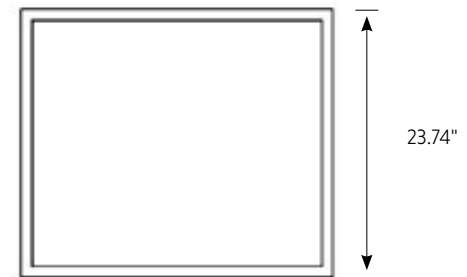

23.74"

23.74"

PRODUCT STRUCTURE

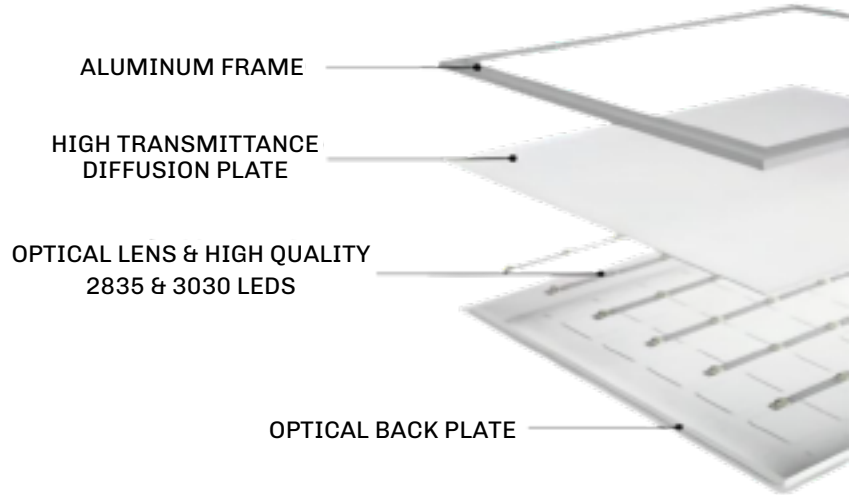

SWITCHES: POWER & CCT



WARNINGS

- Read the product specification carefully first to confirm that the working environment is in line with the condition on the specification before it is used.
- Confirm the input voltage and frequency before use.
- The light must be installed by professional personnel.
- If the power cord and case of the products are damaged, it will be regarded disqualified product and should not be used.
- Dangerous high voltage. Non professional personnel should not repair.
- If external soft cable or wire of the product is damaged, the wire should be replaced by manufacturer or service agent or personnel with similar qualification to avoid danger.